



আর এফ এল

HDPE PIPE



A Product of





আর এফ এল

HDPE PIPE

ABOUT US

RFL started its journey with Cast Iron (CI) products in 1981. The company was founded by Late Maj Gen Amjad Khan Chowdhury (rtd) whose main objective was to ensure pure water and affordable irrigation instruments for improving rural life. With the passage of time RFL expands its business in many other areas and now is one of the leading companies of Bangladesh in PVC Pipe, Metal Pipe, Door, Water Tank, Pump, Motor, Electronics Home Appliance, Fan, Light, Plastic Household, Melamine, Stationery, Bicycle, Furniture, Medical Equipment etc businesses. After meeting the demand of Bangladesh RFL also starts exporting to different countries of the world. RFL is very much hopeful to bear the flag of Bangladesh across the world with pride.

RFL has become a benchmark for competitors on the lines of quality by manufacturing premium quality products to give clients excellent services and true value for money. The unmatched products have given a big name in the domestic market. This is possible because the company is professionally managed and promoted by people who ensure creativity.

RFL Plastics currently utilizes 2500 molds through 350 machines having a growth rate of 40% over last year backed by own tooling facilities in the factory premises. The behind growth story of this brand is expansion & availability of innovative & affordable solution for household durables & utensils.

We are a very strong organization of 5000 employees dedicated to supplying customized and quality plastic products globally.





আর এফ এল
HDPE PIPE

RFL HDPE Pipes



RFL HDPE Pipe Laying

What is Polyethylene?

When scientists first experimented with a reaction between ethylene and benzaldehyde using two thousand atmospheres of internal pressure, their experiment went askew when all the pressure escaped due to a leak in the testing container. On opening the tube they were stunned to find a white waxy substance that looked a lot like some form of plastic. After repeating the experiment, they discovered that the loss of pressure was not due to a leak at all, but was a result of the polymerization process. The residue polyethylene (PE) resin was a milky white, translucent substance derived from ethylene ($\text{CH}_2=\text{CH}_2$). Polyethylene was produced with low to high density.

Low-density polyethylene (LDPE) has a density ranging from 0.91 to 0.93 g/cm³. The molecules of LDPE have a carbon backbone with side groups of four to six carbon atoms attached randomly along the main backbone. LDPE is the most widely used of all plastics, because it is inexpensive, flexible, extremely tough, and chemical-resistant. LDPE is molded into bottles, garment bags, frozen food packages, and plastic toys.

High-density polyethylene (HDPE) has a density that ranges from 0.94 to 0.97 g/cm³. Its molecules have an extremely long carbon backbone with no side groups. As a result, these molecules align into more compact arrangements, accounting for the higher density. HDPE is stiffer, stronger, and less translucent than low-density polyethylene. HDPE is formed into car fuel tanks, packaging and of course piping.



আর এফ এল

HDPE PIPE

With second generation (medium density PE80) the ESCR is improved by increasing the chain branching and lowering the density as much as possible. The creep resistance is decreased to its lowest possible value in order to optimize ESCR; the knee before 50 years @ 20°C disappeared, but the short-term resistance decreased due to the lower density.

In third generation (high density PE80 and PE100) ESCR is improved by branching only the long chains, thereby not decreasing the density (maintaining stiffness/creep resistance). Short chain branches inserted on the longer molecules ensure an efficient increase of the resistance to stress cracking in the long term, while creep resistance is maintained through high density (no branches on short chains that crystallize easily).

PE Classification ISO 4427 - 1996E.

Designation	Classification MRS (MPa)	Design Stress (MPa) Water
PE100	10,0	at 8,0
PE80	8,0	6,3
PE63	6,3	5,0
PE40	4,0	3,2
PE32	3,2	2,5



RFL HDPE Pipe 1400 mm



আর এফ এল
HDPE PIPE

RFL HDPE Irrigation manufactures HDPE Pipe and corrugated plastic pipe for Pipe line networks of Gas, Liquid, Solids & Other applications.

What we refer to as HDPE pipe - also known as Poly Pipe, PE pipe or Polyethylene pipe - is manufactured by extrusion technology in sizes ranging from 16 mm to 1400 mm diameter.



1400 mm RFL HDPE Pipe Production

If you are looking for rugged dependability, light weight, long lasting service, trouble-free installation, flexibility, superior flow rates, high chemical resistant and extremely high corrosion resistance without compromising on efficiency RFL HDPE piping systems are the perfect solution.

If you want to know about this piping system, please contact us and we will gladly answer any of your questions.

Applications of RFL HDPE

Liquid	Gas	Solid	Other
Water Supply Drainage & Sewers Industrial Liquids, Chemicals Marine Works, Sea Intake and Outfall	Gas Piping Land-fill Gas Extractions Ventilation	Dredging Mining	Electrical Conduits Telecom Cable Ducts Manholes Culverts Geother- mal Heating Perforated Pipes

For over twenty-one years we have manufactured plastic pipe for a wide range of industrial, commercial and residential applications. Some of the more popular applications of our PE pipe include Gas pipes, Water mains, Sewers, Drainage and Cable duct.

Normally colours available in PE pipes

Sr. No.	Colour	Application	References
1.	Black	For Sewer	IS 14333
2.	Gray	For Treated effluent	General Practice
3.	Black with blue strips	For water supply	IS 4984
4.	Yellow, Orange	For gas distribution	IS 14885



আর এফ এল

HDPE PIPE

RFL HDPE Pipe-Characteristics

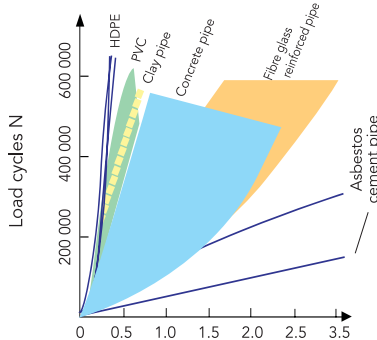
Sr. No.	Features	Characteristics
1	Life Expectancy	PE Pipe has a Life Expectancy of 50 - 100 years.
2	Design Value of Frictional co-efficient	Measurement
		Formula
		Typical Design Value
		Absolute Roughness Friction Factor "C" Roughness Coefficient
		Colebrook Hazen Williams Manning Equation
		0.000005 ft. 150 - 155 0.009
		Remains constant throughout its life span
3	Joint	PE pipe is normally joined by butt fusion method which creates a joint that is as strong or stronger than the pipe itself, and is virtually leak free.
4	Leak Proof	Butt-fused joints Create a homogenous, monolithic joint leading to leak proof system.
5	Corrosion Resistance & Biological Effects	Does not rust, rot, or corrode. RFL HDPE pipes are non-conducting and inert and hence immune to galvanic and electrochemical corrosion. RFL HDPE pipes do not rust or corrode, both inside and outside. PE Pipes do not degrade due to biological effects. They are not digestible and do not contain ingredients that would attract animals like rodents. The expectation ally smooth and flexible surfaces of the RFL HDPE pipes do not offer any abrasion effects to rodent's teeth like steel, CI
6	Chemical Resistance	PE pipe has excellent chemical resistance.
7	UV Protection	Black PE pipe containing 2% (Max) carbon black can be safely used outside in the sun without damage from UV exposure.
8	Impact & Toughness	Tough and good impact resistance.
9	Pressure Rating s & Dia	PE pipe is available in various sizes upto 1400 mm dia. And pressure rating of PN-6, PN-8, PN-12.5, PN-16 (PN= kgf/cm ²)
10	Lightweight	It is lighter than Metal or concrete pipe. It is easier to handle & install as compared to above materials.
11	Flexibility	PE pipe can be bent to a minimum radius of 20 to 40 times the pipe diameter. This flexibility of PE pipe allows I to be curved under , over & around obstacles as well as directional changes.
11	Abrasion Resistance	Good abrasion resistance as compared to other pipe. The performance ratio is 3:1 in favor of PE. 
12	Coiled pipe	PE pipe is also available in coil from up to 75 mm dia. With specific SDR.
13	Earth Quake / Soil settlement resistance	Found good in case of earth quake and soil settlement. RFL HDPE pipes have excellent resistance to environment stress cracking which is due to the combined actions of stress and the environment. The stain ability of RFL HDPE pipes under stress is higher than any conventional pipes, thereby the pipes never fail due to prism loads and soil settlement due to seasonal changes.
14	Water hammer	The water hammer effect in the RFL HDPE pipes are the lowest when conventional Ipipes for similar operating conditions, thereby reducing the safety appurtenances in the system as well the cost of maintenance.
15	Average E-Modulus (MPa)	900 to 1200 MPa.



Temperature Effect

HDPE pipes have a wide range of temperature application. RFL HDPE pipes perform well at temperatures ranging from -40°C to 45°C for pressure applications and upto 80°C for non-pressure gravity-flow applications. However for higher temperature applications, suitable pressure de-ratings should be applied.

Exposed to sunlight installation of RFL HDPE pipes will be subjected to temperature rise and fall during day and night which will cause pipe to change in length as it expands and contracts. Proper precautions should be taken for these linear expansions and contractions to avert damages to the pipe joints. System design should accommodate changes in the pipeline due to linear expansion or contraction. Expansion joints should not be used unless they are specially designed for HDPE pipe systems.

Temperature Rating Tables

Temp°C	Extrapolation limit years	Design Factor	RFL HDPE allowable operating pressure MAOP (m head water)							
			PN4	PN6.3	PN8	PN10	PN12.5	PN16	PN20	PN25
20	100	1	40	64	80	100	127	160	200	250
25	100	1.1	36	58	73	91	115	145	182	227
30	100	1.1	36	58	73	91	115	145	182	227
35	50	1.2	33	53	67	83	106	133	167	208
40	50	1.2	33	53	67	83	106	133	167	208
45	35	1.3	31	49	62	77	99	123	154	192
50	22	1.4	29	46	57	71	91	114	143	179
55	15	1.4	29	46	57	71	91	114	143	179
60	7	1.5	27	43	53	67	85	107	133	167
80	1	2	20	32	40	50	63	80	100	125

Temperature effect on HDPE pipe durability



আর এফ এল

HDPE PIPE

Advantages of RFL HDPE Pipe

Extreme Joint Strength

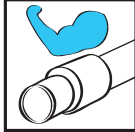

No Thrust Restraint



Common Trenching

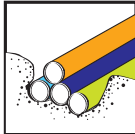

Resistance To Corrosion,
Deposits And Abrasion



High Strength And Flexibility

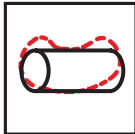

Extreme Durability



Life Low Cycle Costs



High Fluid Flow

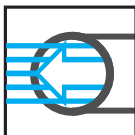

High Quality



Versatility

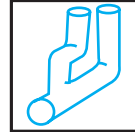

Safe For Drinking Water



Chemical Resistance

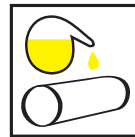

Low Thermal Conductivity

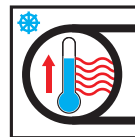

The Green Solution



Cost Effective, Long Term
And Permanent



Ease Of New Connections,
Repairs And Upgrades

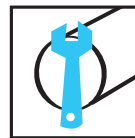

Ease Of Installation





আর এফ এল
HDPE PIPE

RFL HDPE Pipe-Applications

Municipalities, Corporations & Metro Water

- Pumping Mains for Water
- Distribution Mains for Water
- Force Main for Sewer
- Gravity Main for Sewer
- House Service Connections
- Lining of old pipelines
- Horizontal Direction Drilling.
- Pipe Bursting - Replacement of old Pipes
- Dredging
- Storm Water Drain & Diversion

Utility Services

- Natural and LP Gas Distribution
- Untreated and Treated Effluent
- Electrical Cable Ducting
- Optical Fibre Cable Ducting
- Telecommunication Cable Ducting
- Waste Water Treatment
- Aeration and Odour Control Ducting
- Sea Intake & Out fall pipes
- Culverts, Storm Water Drains
- Power Plant : Boiler Blow-down
- Power Plant : Fly-Ash Slurry
- Power Plant: Fire Main
- Reverse Osmosis Pipeline

Mining Industry

- Leach Lines
- Coal Decant Systems
- Mine Drainage
- Coal Tailings
- Slurry and Sludge Transport
- De-watering
- Dust Suppression
- Sand Stowing
- Fire Hydrant Systems

Industry

- Pulp & Paper
- Chemical Process Lines
- Corrosive Liquids
- Water Treatment
- Marine In-take & Out-fall
- Fertilizers
- Rice Mills

Irrigation

- Drip Irrigation
- Lift Irrigation
- Gated Pipe Irrigation
- Sprinkler Irrigation

Landfill

- Leachate Collection & Transportation
- Methane Collection & Transportation



RFL HDPE Pipe 1400 mm



আর এফ এল
HDPE PIPE

RFL HDPE Pipe Dimension Chart as per ISO 4427:2007 Standard

				SDR 6		SDR 7.4		SDR 9		SDR 11	
				S 2.5		S 3.2		S 4		S 5	
PE 100						PN 25		PN 20		PN 16	
Nominal Size	Diameter, mm		Ovality	Wall Thickness, mm							
	dn Min	dn Max	Max	e Min	e Max	e Min	e Max	e Min	e Max	e Min	e Max
16	16.00	16.30	1.20	3.00	3.40	2.30	2.70	2.00	2.30	-	-
20	20.00	20.30	1.20	3.40	3.90	3.00	3.40	2.30	2.70	2.00	2.30
25	25.00	25.30	1.20	4.20	4.80	3.50	4.00	3.00	3.40	2.30	2.70
32	32.00	32.30	1.30	5.40	6.10	4.40	5.00	3.60	4.10	3.00	3.40
40	40.00	40.40	1.40	6.70	7.50	5.50	6.20	4.50	5.10	3.70	4.20
50	50.00	50.40	1.40	8.30	9.30	6.90	7.70	5.60	6.30	4.60	5.20
63	63.00	63.40	1.50	10.50	11.70	8.60	9.60	7.10	8.00	5.80	6.50
75	75.00	75.50	1.60	12.50	13.90	10.30	11.50	8.40	9.40	6.80	7.60
90	90.00	90.60	1.80	15.00	16.70	12.30	13.70	10.10	11.30	8.20	9.20
110	110.00	110.70	2.20	18.30	20.30	15.10	16.80	12.30	13.70	10.00	11.10
125	125.00	125.80	2.50	20.80	23.00	17.10	19.00	14.00	15.60	11.40	12.70
140	140.00	140.90	2.80	23.30	25.80	19.20	21.30	15.70	17.40	12.70	14.10
160	160.00	161.00	3.20	26.60	29.40	21.90	24.20	17.90	19.80	14.60	16.20
180	180.00	181.10	3.60	29.90	33.00	24.60	27.20	20.10	22.30	16.40	18.20
200	200.00	201.20	4.00	33.20	36.70	27.40	30.30	22.40	24.80	18.20	20.20
225	225.00	226.40	4.50	37.40	41.30	30.80	34.00	25.20	27.90	20.50	22.70
250	250.00	251.50	5.00	41.50	45.80	34.20	37.80	27.90	30.80	22.70	25.10
280	280.00	281.70	9.80	46.50	51.30	38.30	42.30	31.30	34.60	25.40	28.10
315	315.00	316.90	11.10	52.30	57.70	43.10	47.60	35.20	38.90	28.60	31.60
355	355.00	357.20	12.50	59.00	65.00	48.50	53.50	39.70	43.80	32.20	35.60
400	400.00	402.40	14.00	-	-	54.70	60.30	44.70	49.30	36.30	40.10
450	450.00	452.70	15.60	-	-	61.50	67.80	50.30	55.50	40.90	45.10
500	500.00	503.00	17.50	-	-	-	-	55.80	61.50	45.40	50.10
560	560.00	563.40	19.60	-	-	-	-	62.50	68.90	50.80	56.00
630	630.00	633.80	22.10	-	-	-	-	70.30	77.50	57.20	63.10
710	710.00	716.40	0.00	-	-	-	-	79.30	87.40	64.50	71.10
800	800.00	807.20	0.00	-	-	-	-	89.30	98.40	72.60	80.00
900	900.00	908.10	0.00	-	-	-	-	102.00	112.00	81.70	90.00
1000	1000.00	1009.00	0.00	-	-	-	-	113.33	125.00	90.20	99.40
1200	1200.00	1210.80	-	-	-	-	-	-	-	-	-
1400	1400.00	1412.60	-	-	-	-	-	-	-	-	-



আর এফ এল

HDPE PIPE

SDR 13.6		SDR 17		SDR 21		SDR 26		SDR 33		SDR 41	
S 6.3		S 8		S 10		S 12.5		S 16		S 20	
PN 12.5		PN 10		PN 8		PN 6		PN 5		PN 4	
Wall Thickness, mm											
e Min	e Max	e Min	e Max	e Min	e Max	e Min	e Max	e Min	e Max	e Min	e Max
-	-	-	-	-	-	-	-	-	-	-	-
-	-	-	-	-	-	-	-	-	-	-	-
2.00	2.30	-	-	-	-	-	-	-	-	-	-
2.40	2.80	2.00	2.30	-	-	-	-	-	-	-	-
3.00	3.50	2.40	2.80	2.00	2.30	-	-	-	-	-	-
3.70	4.20	3.00	3.40	2.40	2.80	2.00	2.30	-	-	-	-
4.70	5.30	3.80	4.30	3.00	3.40	2.50	2.90	-	-	-	-
5.60	6.30	4.50	5.10	3.60	4.10	2.90	3.30	-	-	-	-
6.70	7.50	5.40	6.10	4.30	4.90	3.50	4.00	-	-	-	-
8.10	9.10	6.60	7.40	5.30	6.00	4.20	4.80	-	-	-	-
9.20	10.30	7.40	8.30	6.00	6.70	4.80	5.40	-	-	-	-
10.30	11.50	8.30	9.30	6.70	7.50	5.40	6.10	-	-	-	-
11.80	13.10	9.50	10.60	7.70	8.60	6.20	7.00	-	-	-	-
13.30	14.80	10.70	11.90	8.60	9.60	6.90	7.70	-	-	-	-
14.70	16.30	11.90	13.20	9.60	10.70	7.70	8.60	-	-	-	-
16.60	18.40	13.40	14.90	10.80	12.00	8.60	9.60	-	-	-	-
18.40	20.40	14.80	16.40	11.90	13.20	9.60	10.70	-	-	-	-
20.60	22.80	16.60	18.40	13.40	14.90	10.70	11.90	-	-	-	-
23.20	25.70	18.70	20.70	15.00	16.60	12.10	13.50	9.70	10.80	7.70	8.60
26.10	28.90	21.10	23.40	16.90	18.70	13.60	15.10	10.90	12.10	8.70	9.70
29.40	32.50	23.70	26.20	19.10	21.20	15.30	17.00	12.30	13.70	9.80	10.90
33.10	36.60	26.70	29.50	21.50	23.80	17.20	19.10	13.80	15.30	11.00	12.20
36.80	40.60	29.70	32.80	23.90	26.40	19.10	21.20	15.30	17.00	12.30	13.70
41.20	45.50	33.20	36.70	26.70	29.50	21.40	23.70	17.20	19.10	13.70	15.20
46.20	51.10	37.40	41.30	30.00	33.10	24.10	26.70	19.30	21.40	15.40	17.10
52.20	57.60	42.10	46.50	33.90	37.40	27.20	30.10	21.80	24.10	17.40	19.30
58.80	64.80	47.40	52.30	38.10	42.10	30.60	33.80	24.50	27.10	19.60	21.70
	73.00	53.30		42.90	47.30	34.40	38.30	27.60	30.50	22.00	24.30
72.50	79.90	59.30	65.40	47.70	52.60	38.20	42.20	30.60	33.50	24.50	27.10
		67.90	74.80	57.20	63.10	45.90	50.60	36.70	40.45		
		82.40	90.80	66.70	73.50	53.50	59.00	42.90	47.30		



আর এফ এল
HDPE PIPE

HDPE Pipes & Fittings for House Connection

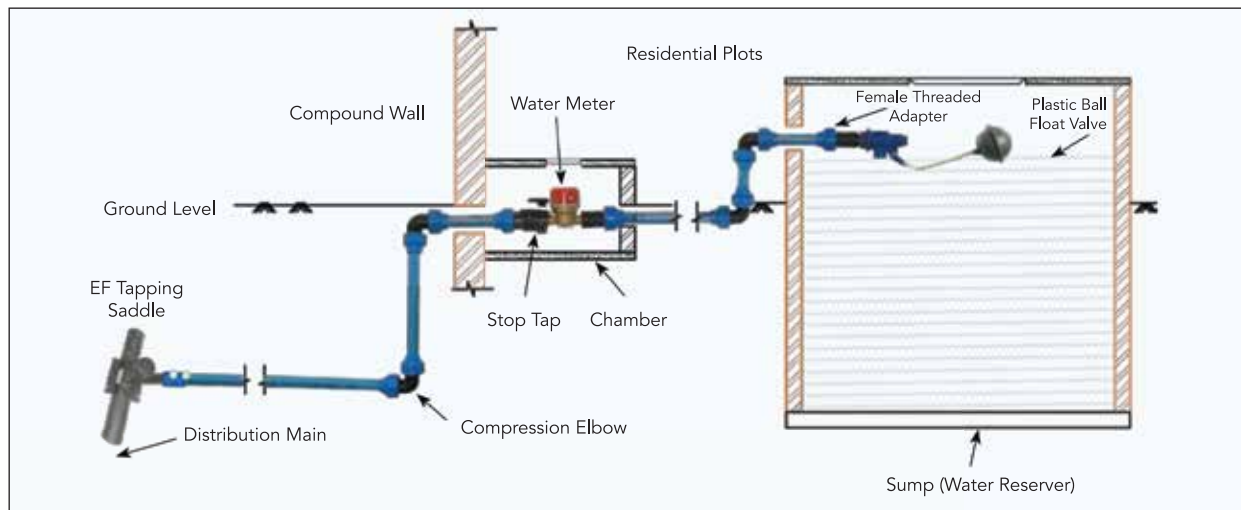

House Connection Schematic Diagram

RFL HDPE pipes for House Service Connection are manufactured from HDPE-80 and HDPE-100 grade blue compounded material, having WRAS certification, recommended world over for distribution of safe potable water under hygienic conditions.

- Very smooth inner surface ensures no scaling and choking.
- Has less friction loss and gives better flow at lower heads.
- Easy to transport and store as the pipes available in 100, 200 and 300 metre coils.
- No wastage of pipe as it can be cut to requirement at site.
- Less number of joint as the pipe is flexible and available in longer lengths.
- 100% leak-proof saving enormous quantity of water wasted in conventional piping system due to corroded leaky joints.
- Easy to repair as the pipes are flexible and joiners are with union and compression type joints.
- Easy tapping with specialty tapping joints.
- Tools-off installation possible with precision made fittings.

Distribution Pipe

It is recommended that Water Utilities providing protected drinking water should use HDPE-80 and HDPE-100 grade pipes. It is a well-known fact that the soil in which the pipes are buried, are of corrosive nature, which triggers outside corrosion of the conventional pipes. Added to this, the leakage of electricity from the underground cables as well as spillage of chemicals and contamination of subsoil with leaky sewerage and drainage pipelines add to the galvanic and chemical corrosion of conventional pipes. Dissolved oxygen and chlorine in the treated water accelerate the inside corrosion.

RFL HDPE Polyethylene HDPE- 80 grade pipes conforming to ISO 4427 as well as IS 4984 & IS 14333 are available up to 1000mm diameter in all pressure classes as per the standard. Installation of these pipes is easy. Tapping for the house service connection is also made very easy with tapping tees and saddles and is totally leak-proof.



আর এফ এল
HDPE PIPE

PLB Optical Fibre Cable Ducts

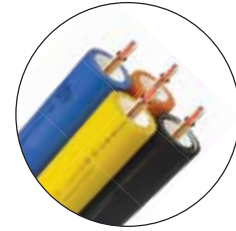

RFL HDPE - PLB Optical Fibre Cable Ducts

- Co-Extrusion process was developed in-house by RFL HDPE in their R&D facility during 1993.
- RFL HDPE Ducts (permanently lubricated) is the result of innovative development in co-extrusion by RFL HDPE
- It is the versatile and unique solution for High Speed Air Blowing (HSAB) of Optical Fibre Cable (OFC).
- RFL HDPE Cable Ducts are manufactured with state-of-the-art machinery using latest processing technology and fulfill the performance requirement of National & International specifications.
- Common Sizes 32/25, 40/33, 50/43, , 63/54
- Approved vendor and supplier to Fiber@Home in india and Summit communications Ltd, ICT Ministry and aslo many customers in other countries as well. Capable of manufacturing tailor-made as per specifications to suit customer's requirements.
- Supplied in coils of various lengths up to diameter 63mm.
- Supplied with pre-inserted PP rope on request.

RFL HDPE Self Lubricated HDPE Duct

RFL HDPE manufacture RFL HDPE SLB HDPE Duct which is the latest innovation from their R&D. RFL HDPE SLB HDPE ducts are manufactured with high performing virgin HDPE material with the inner surface of the duct self lubricated by homogenous construction to give a smooth finish and low co-efficient of friction. RFL HDPE SLB HDPE Ducts have the same constructional stability and strength as that of RFL HDPE Silicoat™ HDPE Duct and can withstand the pressure during HSAB as well as traffic load.

RFL HDPE Silicore HDPE Duct

RFL HDPE Silicore HDPE Duct is extruded from selected high quality virgin HDPE material and co-extruded with special lubricant that is distributed uniformly along the entire inner surface of the duct providing a low friction smooth surface for easy cable drawing or blowing. The outer HDPE make the pipe more tough and durable and enables the duct to withstand the pressure during HSAB of cable as well as retains the roundness under soil pressure and traffic load.



RFL HDPE Ribbed Walled Duct

MAXIMA Ducts can also be supplied with inner lubricated area in ribbed form. Ribbed Wall is ideal for pulling or jetting cable, thus reducing surface contact with cable during installation. It is available in various sizes and colours.



আর এফ এল
HDPE PIPE

RFL HDPE Micro Duct



RFL HDPE Micro Ducts are specifically made for installation in the existing (new or old, empty or preoccupied) HDPE ducts by blowing, jetting or pulling technique. The ducts can be bunched & blown in various combinations & colors thus allowing extra channels for future cabling needs & increased pathway. Its low sliding friction aids in easier blowing & jetting of Micro-ducts & allows longer pulling distance thus increasing duct integrity resulting in quality installation at lower cost.

RFL HDPE Micro-ducts are available in 5mm, 7mm, 8mm, 10mm, 12 mm & 14mm OD with different wall-thicknesses with multiples ways. Micro ducts are available with permanently lubricated smooth inner wall or ribbed inner wall.



RFL HDPE Duct Laying



আর এফ এল
HDPE PIPE

RFL HDPE Butt Fusion Molded Fittings



Features

- **Material:** PE 100
- **Size:** 75 mm through 1400mm availability
- **Pressure Rating:** 1.0Mpa, 1.25Mpa, 1.6Mpa or other nominal pressures available upon request
- **Standard:** ISO 4427-3, EN 12201-3 BS EN 12201-3 AS/NZS 4129 BS 6920
- **Color:** Blue all size
Black (dn 110 or above)
Other colors are also available upon request
- **Joint:** Joining pipe and butt joint fittings by butt fusion joint

Advantages

- **Non- toxic:** No heavy metal additives, would not be covered with dirt or contaminated by Bacterium
- **Corrosion resistance:** Resist chemical matters and electron chemical corrosion
- **Low installation cost:** Light weight and ease of installation can reduce installation costs
- **High flow capacity:** Smooth interior walls results in low pressure loss and high volume
- **Longevity:** More than 50 years under proper use.



আর এফ এল
HDPE PIPE

Butt Fusion Fittings (Molded)

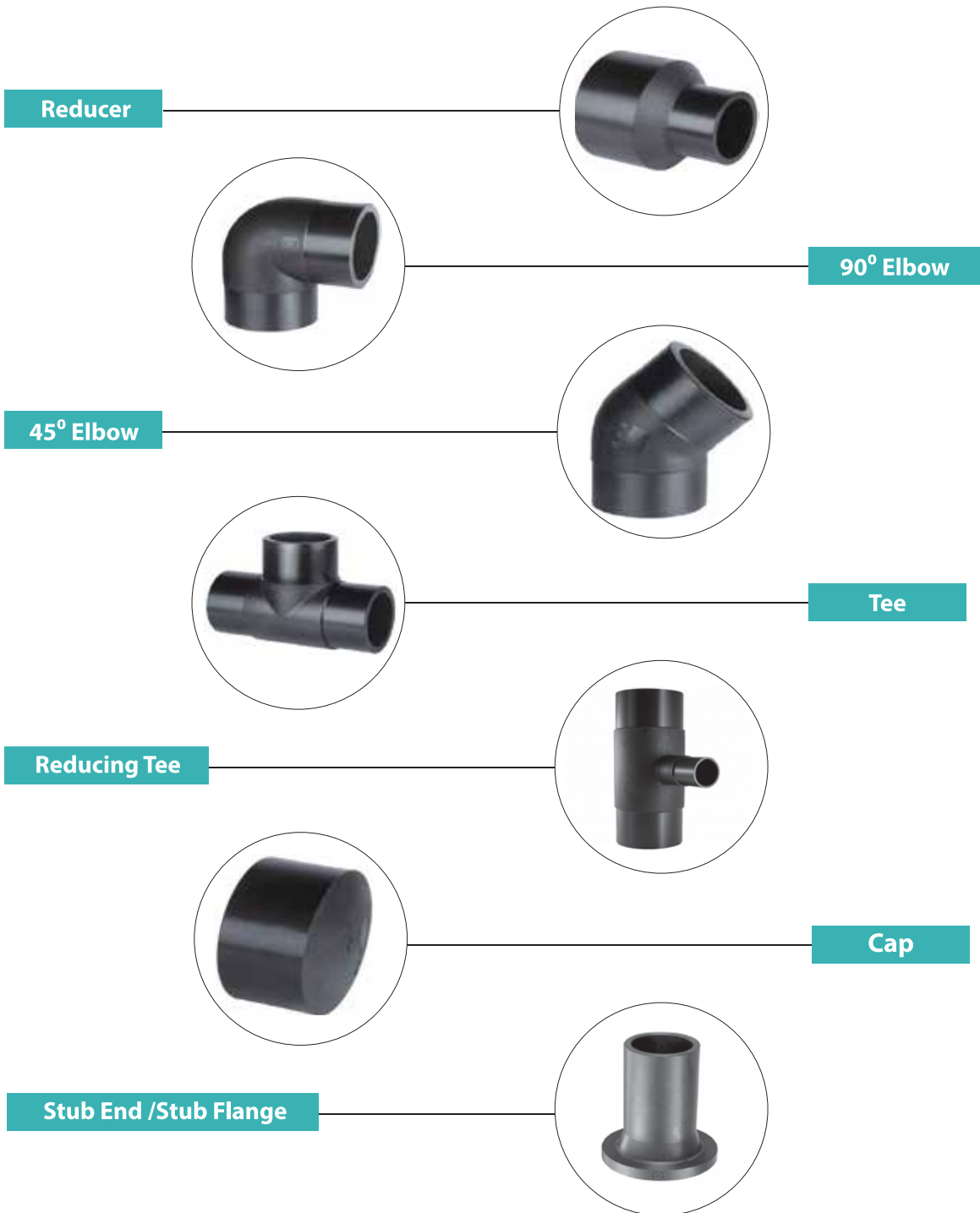



আর এফ এল
HDPE PIPE

RFL HDPE Electro Fusion Fittings



Features

- **Material** : PE 100
- **Size** : 20 mm through 1400mm (upto) availability
- **Pressure Rating** : 1.6Mpa or other nominal pressures available upon request
- **Standard** : ISO 4427-3, EN 12201-3 BS EN 12201-3 AS/NZS 4129 BS 6920
- **Color** : Blue, Black & Other colors are available upon request
- **Joint** : Joining pipe and electro fittings by electro fusion joint

Advantages

- **Non- toxic** : No heavy metal additives, would not be covered with dirt or contaminated by Bacterium
- **Corrosion resistance** : Resist chemical matters and electron chemical corrosion
- **Low installation cost** : Light weight and ease of installation can reduce installation costs
- **High flow capacity** : Smooth interior walls results in low pressure loss and high volume
- **Longevity** : More than 50 years under proper use.



আর এফ এল

HDPE PIPE

Electro Fusion Fittings

E/F Coupling



E/F 90° Elbow

E/F Reducer



E/F Stub End/ Stub Flange

E/F 45° Elbow



E/F Tee

E/F Reducing Tee





আর এফ এল
HDPE PIPE

RFL HDPE Butt Fusion Fabricated Fittings



Features

- **Material** : PE 100
- **Size** : 75 mm through 1400mm availability
- **Pressure Rating** : 0.6Mpa, 1.0Mpa, 1.6Mpa or other nominal pressures available upon request
- **Standard** : ISO 4427-3, EN 12201-3 BS EN 12201-3 AS/NZS 4129 BS 6920
- **Color** : Blue, black with blue stripes or others color available upon request
- **Angles** : Various angles available upon request
- **Joint** : Joining pipe and fabricated fittings by butt fusion joint

Advantages

- **Non- toxic** : No heavy metal additives, would not be covered with dirt or contaminated by Bacterium
- **Corrosion resistance** : Resist chemical matters and electron chemical corrosion
- **Low installation cost** : Light weight and ease of installation can reduce installation costs
- **High flow capacity** : Smooth interior walls results in low pressure loss and high volume
- **Longevity** : More than 50 years under proper use.



আর এফ এল
HDPE PIPE

Butt Fusion Fabricated Fittings

B/F Fabricated 90° Elbow



B/F Fabricated 45° Elbow

B/F Fabricated Tee



B/F Fabricated Reducing Tee

B/F Cross Tee



B/F Y Tee

* All size are available



আর এফ এল
HDPE PIPE

RFL HDPE Compression Fittings and Saddle Clamp





RFL HDPE Compression Fittings and Saddle Clamp

Fields of Application

RFL HDPE Compression fittings and clamp saddles are designed specifically for connecting polyethylene pipes with an outside diameter of 20-200 mm (135mm for clamp saddles). They are fully compatible with all PELD, PEHD, PE 40, and PE80 & PE 100 Pipes complying with EN 12201, ISO 4427, ISO 14236, ISO 13460 and DIN 8074. They are normally used to convey drinking water and liquids at pressure up to 16 bars for generic applications. The quality of the materials used makes these fittings resistance to etching to by numerous chemical substances and to UV-rays. The RFL HDPE universal fitting can be used to connect systems using HDPE metric piping with existing pipes made of any material with external material diameter of 20-63 mm.

Standards

Fittings and saddles

Complying with UNI 9561, UNI9562, DIN 8076-3, ISO 14236, ISO 13460

Threads

Complying with 1807/1, DIN 2999, BS 21

Available Size:

20 mm, 25 mm, 32 mm, 40 mm, 50 mm & 63 mm all compression fittings are PN-16

Quality certifications

RFL HDPE fittings have been tested and approved by all the leading certification agencies.
RFL HDPE quality system is ISO 9001:2015 certified.

OPERATING TEMPERATURES

Fittings and clamp saddles are not suitable for use with hot water for the limits dictated by the use of polyethylene pipes.

RFL HDPE operating temperatures refer to the use of polyethylene pipes. It is therefore necessary to refer to the regulations applicable in the country of use. The fittings and clamp saddles can with stand temperatures below 0-c. The table below shows the maximum operating pressure during continuous operation (PFA) with changes in temperature. If the liquid conveyed is water, in compliance with EN 805, EN 12201, and ISO 13761.

Operating T[C]	<20	25	30	35	40	45
PFA[bar]	16	14.9	13.9	12.6	11.8	10.8
PFA[bar]	10	9.3	8.7	8	7.4	6.7



আর এফ এল

HDPE PIPE

Compression Fittings



Saddle Clamp

Female Union Ball Valve



Female Coupler

Male Adaptor



Female Adaptor

Compression Tee



Male Elbow

90° Joint Elbow





আর এফ এল
HDPE PIPE

Assembly Instruction

Compression fittings 20mm-63mm



01
Cut the pipe squarely using special pipe cutting tools or circular or band saw. It is advisable to use a guide box to ensure a square cut.



02
Eliminate any burrs and bevel the end of the pipe to facilitate easy assembly and to prevent damage to the fitting gasket. The outer surface of the pipe must be free from imperfection where the body of the fittings makes contact with the pipe.



03
Unscrew the blue nut and put it into pipe followed by the white clamping ring. Make sure the clamping ring is in the correct position, with largest diameter facing the fitting.



04
Press the pipe axially into the fitting, past the gasket until it touches the internal register inside the fitting body.



05
Tighten the ring nut by hand and then use the torque wrench provided. The ring must be tight, but it does not need to reach the end of the fitting body.

Compression fittings 75mm-110mm



01
Cut at 90degree the pipe extremity to be connected and eliminate possible flashes.



02
Unscrew of 3-4 turns the fitting nut and make sure that the OR and the blocking bush are in the highlight position.



03
Introduce the pipe into the fitting till reaching the three ribs in the inside wall of the body.



04
Screw the nut up to the end using a belt or chain wrench.



আর এফ এল

HDPE PIPE

Assembly Instruction

Clamp saddles –Alternative procedure



01 Select the hole points and makes sure that the external surface of the pipe is free from any impurity; put the gasket into the indentation of the saddle seat.



02 Position the bottom part of the saddle on the chosen point and couple the upper part, then insert the screws from below and tighten the nuts one by one.



03 Drill a hole in the pipe wall , be careful not to damage the thread and the O-



04 Use a marker to draw a reference line on the pipe to allow re installing the saddle, unscrew the nuts and remove the saddle.



05 Drill the hole in the pipe wall being careful not to damage the other side of the pipes and remove the scraps.



06 Assemble the saddle according to the marked line, to keep the hole in the same axis with the saddle's screw hole.



আর এফ এল
HDPE PIPE

RFL HDPE Pipe Joint Standard

(Butt Fusion Joint)

Step: (Use Butt Fusion Welding Machine)



- 01 **Prepare:**
Prepare the necessary tools.



- 02 **Clamp and clean:**
Clamp down the pipe on the jig, clean up the joint part, mill the joint sides, and then adjust the joint parts to make the misplacement less than 10% of the wall thickness.



- 03 **Heat:**
Put the heating panel.

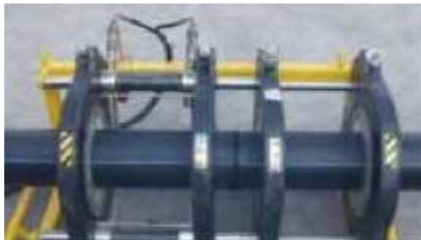

- 04 **Join:**
Remove the heating panel after finishing heating, join the two heating parts swiftly, increase pressure up to the fusion-joint pressure and keep until it cools down.



- 05 **Complete:**
Butt Fusion Joint is completed.



আর এফ এল

HDPE PIPE

RFL HDPE Butt Fusion Welding Standard

Size	PN	SDR	Heater Plate Temperature	Heating Time	Joint Pressure	Cooling Time	Bead Size, mm	
mm	Bar		Deg C	Sec	MPa	Sec	Min	Max
75	10	17	220	80	1.5	120	8	15
90	10	17	220	90	1.5-2.0	180	8	15
110	10	17	220	120	2.00-2.5	220	9	16
160	10	17	220	240	2.5-3.0	240	9	16
200	10	17	220	240	2.5-3.0	240	10	17
250	10	17	220	240	2.5-3.0	240	10	17
315	10	17	220	600	3.0-3.5	450	14	23
400	10	17	220	600	3.0-3.5	480	15	24
450	10	17	220	600	3.5-4.0	600	16	25
500	10	17	220	600	4.0-4.5	600	16	25



Butt Fusion Welding



আর এফ এল

HDPE PIPE

RFL HDPE Pipe Joint Standard

(Electro Fusion Joint)

Step: (Use Electro Fusion Welding Machine)



01

Clean and mark

- Clean up the connection part, mark the inserting depth.

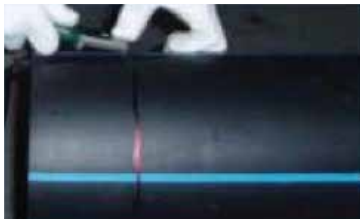

02

Scrape

- Scrape and polish the joint.



03

Align and restrain the fittings to the pipes.



04

Apply electric current

- Apply electric current to the fittings; the joining parts will be heated and melted, turn off the current when there is melt flowing in the observation hole.



05

Cool

- Cool without movement or pressure.



আর এফ এল

HDPE PIPE

RFL HDPE Dredging Solution

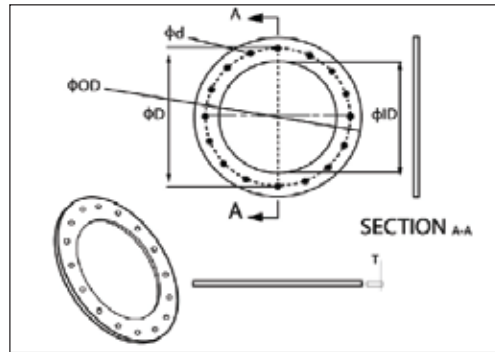

RFL HDPE Dredging Pipe

Flange ring specification								Bolt specification
S/L No	Size	GI Ring Plate ϕOD (mm)	GI Ring Plate ϕID (mm)	GI Ring Plate thickness T (mm)	Total number of hole (Nos)	Hole Diameter ϕd (mm)	Hole to Hole center distance ϕD (mm)	Nut-Bolt size mm (Half thread with washer)
1	315mm (12")	430	322	15 \pm 1	12	22	390	M20X160
2	450mm (16")	572	460	20 \pm 1	16	22	530	M20X180
3	500mm (18")	646	510	25 \pm 2	20	25	605	M24X200
4	560mm (20")	712	570	25 \pm 2	20	28	664	M24X200
5	630mm (22")	780	650	25 \pm 2	24	30	730	M24X200
6	710mm (26")	880	730	25 \pm 2	24	30	830	M24X235



RFL HDPE Dredging Floater

Product Range Information
Size: 315, 400, 450, 500, 560, 630, 710 (mm)



Rubber Hose

Product Range Information
Size: 400, 450, 500, 550, 600, 650, 700, 750, 800, 850, 900 (mm)



আর এফ এল

HDPE PIPE

RFL HDPE Pipe For Firefighting Line



Specifications

Usage: Firefighting line

Size: 20mm to 1400mm.

Pressure: 0.5MPa, 0.6MPa, 0.8MPa, 1.0MPa
1.25MPa, 1.6MPa, 2.0MPa.

Standard: ISO4427, EN12201, AS4130 etc.

Color: Black or customized.

RFL HDPE Pipe For Gas Line



Specifications

Material : PE 100

Pressure Rating : PN \leq 0.5MPa, PN \leq 1.6MPa
PN \leq 0.5 MPa & PN \leq 0.7 MPa

Size: 20 mm through 1000mm availability

Standard : ISO4437

Colors: Yellow, Black with yellow stripes
other colors upon request

Form supplied: • 6 meter straight length (dn>63).

• 50 or 100 meter coil length (dn20~ dn>63).

• Others form are also available upon request.

Advantages:

- **Corrosion resistant:** Resist chemical matters and electron chemical resistance
- **Low flow resistance:** Smooth interior walls and low friction
- **Excellent flexibility :** Can be supplied in coil
- **Easy installation :** Light weight & handed friendly
- **Longevity :** Can work more than 50 years under proper use
- **Various joint availability :** Butt fusion joint, electro fusion joint & transition joint
- **Recycled & environment- friendly**



আর এফ এল
HDPE PIPE

Laboratory Test Arrangement



Moisture Content Test



COF Test



Hydrostatic Pressure Test



Impact Test



Acetone Test



Carbon Black Content Test



Crush Resistance Test



Density Test



Dumbbell Cutter



ESCR Test



Heat Reversion Test



Melt Flow Index Test



OIT Test



Opacity Test



Particle Analyzer Test



Sulphated Ash Content Test



Tensile & Compressive Test



আর এফ এল
HDPE PIPE

Work Experience with RFL HDPE



RFL HDPE Dredging Line
at Cox's Bazar air port extension work



RFL HDPE Pipe Line at Tea Garden,
Chittagong



RFL HDPE Potable Water Line,
DWASA ICB02.7 Package



আর এফ এল
HDPE PIPE

Work Experience with RFL HDPE



RFL HDPE Water Distribution Line
at Modunaghat Water Treatment Plant, Chittagong



RFL HDPE Water Distribution Line at Bangladesh
Tannery Effluent Treatment Project, Savar



RFL HDPE Sewerage Pipe Line
at Hotel Intercontinental, Dhaka



আর এফ এল
HDPE PIPE

Our Achievement



BANGLADESH STANDARDS AND TESTING INSTITUTION
MAAN BHABAN
(Physical Testing Wing)
116/A, Tejgaon, Industrial Area, Dhaka-1208.

Phone : 8870280, 8870293

TEST REPORT

Test Report No : 151280

Customer's Reference No: 46.113.618.00.00 G-104(Vol-1)DESWSP/1365 Date of receipt of sample: 05.01.2016 Identification of test items: PE / 2917 (15-16) HDPE Pipe, d _s =110mm, PE=100, PN=10 Manufactured by: M/s. Rangpur Foundry Limited, Dhaka. (Stated). Name and address of customers: কক্সবাজার প্রকৌশলী ও প্রকল্প পরিচালক DESWSP, সকা গার্মেঞ্জ। WASA Bhaban (8 th floor), 98, Kazi Nazrul Islam Avenue, Kawran Bazar, Dhaka-1215.	Lab. Reference No: 36.095.011.06.77.011.2013.01 Date of testing: 18.01.2016 Sampling plan: Not mentioned Test method used: BDS ISO 4427- 1 & 2: 2010
--	---

Condition of the test item: Sample was received in good condition with signed.

Sl Nos	Description of Tests	Standard Limits as per ISO	Test results
1.	Colour	Shall be either blue or black or black with blue stripes	Black with blue stripes
2.	Mean outside diameter in mm.	Min ^m 110.0 & Max ^m 110.7	110.0
3.	Out of roundness (ovality) in mm-	Max ^m 2.2	1.4
4.	Pipe wall thickness in mm.	Min ^m 6.6 & Max ^m 7.4	7.4
5.	Longitudinal heat reversion test: Change of length in percent (Air oven method).	Max. ^m 3.0	1.0
6.	Hydrostatic strength at 20°C at 1.84 MPa (18.4 bar)	No failure of any test piece during test period	No failure occurred
7.	Elongation at break in percent	Min ^m 350	390.0
8.	Density in Kg/m ³	Min ^m 930	961

 21.01.16
 Tested by
 Engr. Md. Hossain Rahman
 Executive (QA Dept, Physical)
 BSTI, Dhaka-1208

 21.01.16
 Checked by
 Engr. Md. Abdus Sebur
 Assistant Director (Physical)

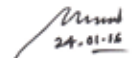
 24.01.16
 Authorized signatory
 Engr. Mathur Rahman
 Deputy Director (Physical)
 BSTI, 116/A, Tejgaon I/A, Dhaka.

N.B.

- i) The results reported above pertain only to the sample tested and supplied to the Laboratory.
- ii) This report when required to be quoted or reproduced, has to be reproduced or quoted in full.
- iii) Reports are not allowed to be used or reproduced for any commercial purpose.
- iv) Any complaint about test report if any should be reported within a month.
- v) The surplus portion of the samples may be auctioned/disposed off after three months from the date of issue of the said report.

BSTI Certificate



আর এফ এল
HDPE PIPE

Our Achievement

কৌশল বিভাগ
স্বাস্থ্য-প্রকৌশল বিশ্ববিদ্যালয়
ঢাকা-১০০০, বাংলাদেশ

007614
15 DEC 2015

Department of Mechanical Engineering
Bangladesh University of Engineering and Technology
Dhaka-1000, Bangladesh

TEST REPORT OF HDPE PIPE 14 December 2015

CLIENT : জনাব মোঃ মাহমুদুল ইসলাম
স্বাস্থ্যকর্তার প্রকৌশলী ও প্রকল্প পরিচালক
DESWSP
সেতল কামাল, সেতল

CLIENT'S REFERENCE : Memo No. 46.113.616.00.00 G-104(Vol-1)DESWSP1210;
Dated: 04.11.2015

UNIVERSITY REFERENCE : BRTC NO. 1100-95598/ME/15-16; Dated: 04.11.2015

AMPLES SUPPLIED : HDPE Pipe

MANUFACTURER : RFL Plastics Ltd.

TEST CONDUCTED BY : DEPARTMENT OF MECHANICAL ENGINEERING
BUET, DHAKA-1000

TEST RESULTS

Color:
Standard used: ISO 4427-2:2007 (E), Supplier's Specification

Nominal Size (mm)	Observation	Remarks
250	Black with blue stripes	Conforms to color code of drinking water supply pipe
315	Black with blue stripes	Conforms to color code of drinking water supply pipe

Dimension (OD and thickness)
Standard used: ISO 4427-2:2007 (E), Supplier's Specification

Nominal Size (mm)	Measured OD (mm)	Thickness (mm)	Remarks
250	249.4 - 253.5 Avg: 252	18 - 16.9, Avg: 16.4	Both OD and thickness conform to requirements of standard
315	314.3 - 315.7, Avg: 315	18.7 - 20, Avg: 19.5	Both OD and thickness conform to requirements of standard

Ovality:
Standard used: ISO 4427-2:2007 (E), Supplier's Specification

Nominal Size (mm)	Measured Ovality (mm)	Maximum Allowable Ovality (mm)	Remarks
250	1.5	5	Conforms to the requirement of the standard
315	0.7	11.1	Conforms to the requirement of the standard

Tensile Strength:
Standard used: ISO 4427-2:2007 (E), ASTM F 2160 / BS 2762 and Supplier's Specification

Nominal Size (mm)	Measured Value (MPa)	Minimum Specified Value (MPa)	Remarks
250	26 - 28, Avg: 27	20	Conforms to the requirement of the standard
315	26.9 - 31.5, Avg: 29.8	20	Conforms to the requirement of the standard

Elongation at break
Standard used: ISO 4427-2:2007 (E), Supplier's Specification

Nominal Size (mm)	HDPE MR5 grade	Measured Value (%)	Minimum Specified Value (%)	Remarks
250	PE 100	490 - 640, Avg: 520	350	Conforms to the requirement of the standard
315	PE 100	500 - 650, Avg: 550	350	Conforms to the requirement of the standard

Amir Hossain
15/12/15
Professor and Head
Mechanical Engg. Dept.
BUET, Dhaka-1000
Bangladesh

Phone : 9665636, 9665650-80/7230, 7232; Fax : 880-2-8613046, 9665622, 9665636; Email : headme@me.buet.ac.bd

BUET Certificate



আর এফ এল

HDPE PIPE

Our Achievement

WASA DHAKA ENVIRONMENTALLY SUSTAINABLE WATER SUPPLY PROJECT
DHAKA WATER SUPPLY & SEWERAGE AUTHORITY
DESWSP, DHAKA WASA

Memo No. : 46.113.618.00.00.G-104(Vol-1)/DESWSP/376 Date : 06-01-2016

To
The Team Leader
Management Supervision Consultant (MSC)
Banosree, Rampura
Dhaka-1219.

Subject: HDPE Test Report (PE-100)

Reference No : 46.113.618.00.00.G-104(Vol-1)/DESWSP/1210, Date: 04-11-2015
Reference No : 46.113.618.00.00.G-104(Vol-1)/DESWSP/247, Date : 19-11-2015

Dear Sir,
With reference to this above vide memo No. 46.113.618.00.00.G-104(Vol-1)/DESWSP/247, Date: 19-11-2015, the PMU office received the test report of HDPE pipe from BRTC, BUET which is found satisfactory (enclosed). The testing of HDPE Pipe is conducted by BRTC, BUET. This is for your further necessary action.

With Best Regards

(Md. Mahmudur Islam)
Superintending Engineer & Project Director
DESWSP, DWAS
Dhaka.

Enclosed : As stated.

Copy to :

1. Contract Manager, ICB-02.7, (RPL-FSL-CRFG-IV)
2. SE & DPD-2, DESWSP, DWASA
3. Office Copy

WASA Bhaban (8 th floor), 96, Kazi Nazrul Islam Avenue, Kewran Bazar, Dhaka-1215, Bangladesh
Tel : 88-02-8185095. www.deswsp-dwasa.com, e-mail: pddeswsp@gmail.com

DHAKA WASA

Phone : 9665638, 9665650-80/7230, 7232; Fax : 880-2-8613046, 9665622, 9665638; Email : headme@me.buet.ac.bd

DWASA Certificate



আর এফ এল
HDPE PIPE

Our Achievement



ISO 9001:2015



আর এফ এল
HDPE PIPE

Our Achievement



OHSAS 18001:2007



আর এফ এল

HDPE PIPE

Our Achievement



ISO 45001: 2018

A Product of



আর এফ এল

 Hotline (Call Charge Free)
0800 7777 777

 /RFL-Pipe-and-Fittings

PRAN Center, 105 Pragati Sarani, Middle Badda, Dhaka 1212, Bangladesh
Phone : 02222281792, Fax : 88-02-8837464
E-mail : rfl@prangroup.com Web : www.rflpipes.com